

Installation User Manual

MC201

Contents

Introduction	3
1. System Overview	4
1.1 Product Overview	4
1.2 Schematic Diagram Powered by Standard Power Cable	4
2. Installation Preparation	5
2.1 Installation Technical Requirements	5
2.2 Understanding the Installation Environment	5
2.3 Vehicle Condition and Related Electrical Information	5
2.4 Vehicle Power Connection	5
3. Preparation for Installation Materials and Tools	7
3.1 Package Inventory Check	7
3.2 Installation Materials and Tools	7
3.3 Preparing Nano SIM Card and Micro SD Memory Card	9
4. Installation	9
4.1 Installing Nano SIM Card and Memory Card	9
4.2 Choice of Installation Area for the Main Unit	10
4.3 Installation of the Main Unit	12
4.4 Adjustment and Fixation of the Device	12
4.5 Power Connection, Signal Cable, and Cable Connection	13
5. Device Configuration	14
6. Acceptance and Cleaning	14
6.1 Cleaning	14
6.2 Installation Acceptance	14

Introduction

To guide engineers in the correct and efficient installation of MC201 and its accessories, and to improve installation efficiency, this MC201 Solution Installation Guide has been prepared.

This document primarily includes: Preamble, System Overview, Installation Preparation, Installation Introduction, Acceptance, and Cleaning. This document is intended for installation engineers.

We reserve the right to interpret this document and modify the information and descriptions contained herein. In the event of any changes to the content of this manual, no separate notification will be provided.

Important Notice

1. Prior to installation, park the vehicle on level ground and turn off the engine (do not park the vehicle on slopes or inclined roads).
2. Please carefully read the section on packing list and thoroughly inspect upon unpacking.
3. Please carefully read the section on tool list and ensure the availability of installation tools prior to proceed the installation.
4. Prior to installation, observe the vehicle's surroundings and adhere to the following principles:
 - a. The installation position and wiring of the product should not obstruct the driver's visibility or adjustment of the rear-view mirror and sun visor.
 - b. The lens for monitoring the road conditions ahead of the vehicle must be within the working range of the windscreen wipers.
 - c. The installation position of the in-cabin driver monitoring camera should comply with local regulations.
 - d. The installation position should facilitate the replacement and maintenance of the Micro SD card and Nano SIM card.
5. Choose a suitable installation position based on the vehicle's environment. This document serves as a reference only.
6. Select the appropriate power connection method based on the vehicle's environmental conditions. Power connection should be performed by professionals, as improper operation of

the vehicle's power system by non-professionals may be dangerous. This document serves as a reference only.

7. If any issues arise during the installation of special vehicles, please contact the product supplier promptly for support.

8. During installation, the configuration APP application is required for debugging and configuring the MC201.

9. Scan the QR code below or search for and download the configuration APP application from the application store. Once downloaded, you can connect the application to the MC201 to configure the device's operational parameters.



Android

1. System Overview

1.1 Product Overview

MC201 is an smart AI dash cam with one built-in 2K road view camera and one external 1080P camera. It helps drivers reduce traffic accidents and assists fleet management in improving efficiency. Based on artificial intelligence technology, it can proactively detect dangerous driving events and unsafe driving behaviors. It supports sending local real-time alerts to the driver to avoid risks and uploads the events to the fleet management platform for driver training. It transmits real-time and accurate vehicle location information and operational data to the fleet management platform. It provides high-quality remote intercom and real-time video playback, making fleet management easier and more efficient.

This product is suitable for various weather conditions such as day and night, sunny, and rainy. It can be installed in vehicles such as buses, taxis, passenger cars, trucks, hazardous goods transport vehicles, school buses, dump trucks, and sanitation vehicles.

1.2 Schematic Diagram Powered by Standard Power Cable

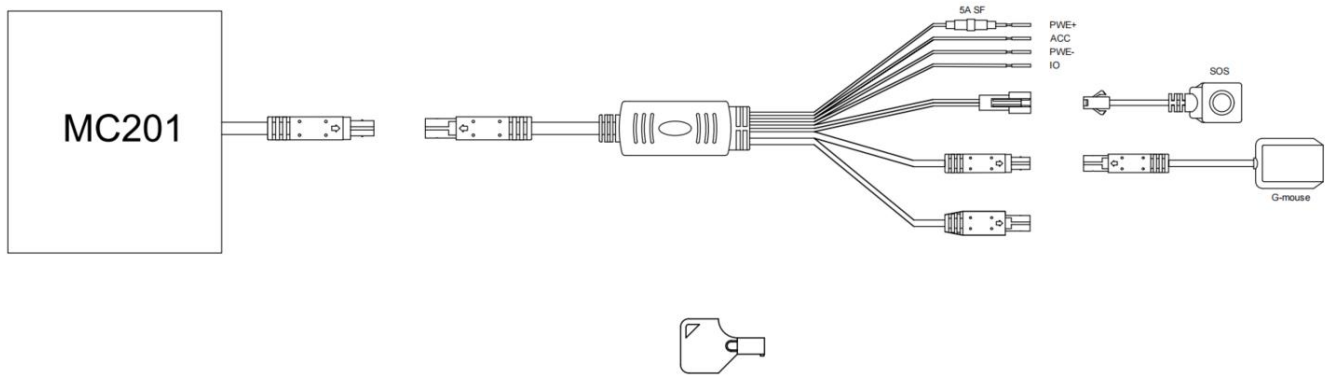

2. Installation Preparation

2.1 Installation Technical Requirements

Installation engineer should be familiar with the product's features, applications, and overall composition. Installation engineer should have knowledge of vehicle circuits, structures, and commonly used installation methods for in-vehicle devices.

2.2 Understanding the Installation Environment

Before equipment installation, Installation engineer should have a clear understanding of the vehicle model, installation position of the device, cable types and lengths required for different vehicle models, and the list of commonly used auxiliary materials. This ensures the smooth completion of equipment installation and debugging.

2.3 Vehicle Condition and Related Electrical Information

Confirmation of vehicle information is the basic prerequisite for successful installation and the assurance of role allocation to avoid vehicle damage. For each component, the next step can only proceed after clear confirmation, with confirmation by the vehicle responsible person and the installation personnel for each operation.

- (a) Check for any damage to the vehicle's exterior and interior components.
- (b) Check if the vehicle can be started normally.
- (c) Check the status of the vehicle's power supply system.

**Note: Confirming the above information is crucial. Installation can only proceed after confirmation of normal conditions.*

2.4 Vehicle Power Connection

It requires the operation of professional installers. The following mainly describes the method of connecting the vehicle's power supply according to the product's power cable requirements.

(1) Tools Required: Multi-meter

(2) Selection of Power Connection Location

When the vehicle is parked and ignition is OFF, use a multi-meter to check if the circuit is powered. If it is positive, it is determined to be a constant power supply, and then measure the voltage.

When the vehicle is parked but the ACC is ON or ignited position, use a multi-meter to check if the circuit is powered. If it is negative when ACC is OFF and positive when ACC is ON, it is determined to be the ACC cable, and then measure the voltage.

(3) Voltage Measurement at Power Connection Point

Constant Power Supply: With the vehicle is parked and ignition is OFF, use a multi-meter to measure the voltage of the constant power supply cable, which is approximately 24V or 12V. If multiple cables have voltages within this range, select the cable with higher current as the constant power supply connection cable.

ACC: When the vehicle ACC is in the ON position or ignited state, use a multi-meter to measure if the voltage is 24V or 12V. If it is 0 in the OFF state and 24V or 12V in the ACC ON position or ignited state, select the cable as the ACC power supply connection cable.

**Note: When connecting the power supply, measure the positive and negative terminals of the power supply first with a multi-meter to avoid errors.*

3. Preparation for Installation Materials and Tools

3.1 Package Inventory Check



After unpacking the product, please ensure the device is intact and all accessories are included.



3.2 Installation Materials and Tools

Installation Materials and Tools List				
#	Image	Name	Usage	Quantity
1		Common Screwdriver Kit	Tighten Screws(Optional)	1pcs
2		Crowbar	Pry Up the Vehicle Panel	1pcs

3		Ties	Bundle Cables	As Per Needs
4		Cleaning Cloth	Clean the Dashboard	1pcs
5		Android Phone	Install the Configuration App for Video Preview and Parameter Configuration	1pcs
6		Measure Tape	Measure the Installation Height of the ADAS Camera and Assist the Installation in other Scenarios	1pcs
7		Mark Pen	Mark Lines for Installation	1pcs
8		Cutting Nippers	Cut and Strip Wires	1pcs
9		Insulated Rubber Tape	Wrap Wire Ends	1pcs
10		Scissors	Cut Insulated Rubber Tape or Wire Clip	1pcs
11		TF Card Reader	For Future Use	1pcs
12		Multi-meter	Locate Vehicle Power Supply	1pcs
			Measure the Conduction of Harness	
			Measure Pulse Signal	
13		3M Adhesive Tape	Fix DMS Camera	1pcs

14		Three Legged ladder	Help to Install the BSD Camera	1pcs
15		Waterproof Sealant	Waterproof Backfill after Punching	1pcs
16		Waterproof Tape	Waterproof Protection for Outdoor Wire Connectors	1pcs

3.3 Preparing Nano SIM Card and Micro SD Memory Card

To ensure proper online communication and data storage of the device, please prepare a compatible Nano SIM card and a Micro SD memory card that meets the quality requirements before installation.

4. Installation

4.1 Installing Nano SIM Card and Memory Card

Installing the Nano SIM card and Micro SD card as shown in the following diagram (pay attention to the insertion direction of these cards). During installation, make sure it feels smooth and flexible. When pushing the card, you should hear a clear "click" sound, indicating that the card is correctly inserted. If you feel significant friction or resistance during installation, it means the card is inserted in the wrong direction. In such cases, promptly remove the card to avoid damaging it.

If the Micro SD card and Nano SIM card are too small to be inserted into the slot manually, you can place the card into the slot and then use the included pry tool to push it in.

[Diagram: Insertion of Nano SIM card and Micro SD card]

***Note:**

(1) Due to the operating temperature range of the device from -20°C to $+70^{\circ}\text{C}$, the Micro SD card and Nano SIM card should be able to work properly for an extended period in harsh environments. Specifically, the metal contacts on consumer-grade Micro SD cards and Nano SIM cards are prone to oxidation under prolonged exposure to heat, humidity, or salt spray conditions. Frequent insertion and removal of cards can lead to contact wear, and the card slot can experience deformation or bending under constant pressure, resulting in poor contact. Therefore, if you are using a Nano SIM card, for industrial equipment, industrial plastic or ceramic M2M cards (MP2 / MP3 / MS1 grade) with a working temperature range of -40°C to 105°C is recommended. If using a Micro SD card, an industrial-grade Micro SD card should be used, which offers strong stability and can be used within a wide temperature range (-40°C to 85°C). For safety purposes, when purchasing the device, it is recommended to use Micro SD cards that have been verified by our company. If you choose to purchase unverified Micro SD cards, there may be a risk of damaging the device, thus affecting its lifespan.

(2) Before installing the Nano SIM card, please check the metal contact surface of the Nano SIM card for any dirt (such as dust, fingerprints, or watermarks). If there is any, use a non-woven cloth or rubber to clean the surface.

(3) When installing the Nano SIM card, avoid touching the metal surface of the Nano SIM card with your hands to prevent contamination from dust and sweat.

After installing the Nano SIM card and Micro SD card, tighten the card slot panel and the screws.

Once the Nano SIM card and Micro SD card are installed, remove the lens protective film from the front and rear lenses of the device.

4.2 Choice of Installation Area for the Main Unit

The installation area requirements for MC201 are as follows:

(1) The device must be installed in the middle of the windshield. Typically, it is installed in the area above the center line of the windshield, in the vicinity of the rear-view mirror. If it is not possible to install the device in the middle as required, a deviation of less than 5cm to the left or right is allowed (the deviation of the device relative to the center line of the windshield is calculated using the center line of the front lens).

(2) The lens of the road condition monitoring camera must be within the working range of the left and right windshield wipers (ensuring that the screen of the road condition monitoring lens is clean and free from stains).

(3) It is recommended to avoid installing other electronic devices, including smart rear-view mirrors, electronic tags, etc., around the device, as it may affect the device's positioning signal.

The installation position should ensure that the main unit does not obstruct the driver's view of the front blind spot reflector, and there are no obstacles (such as the interior rear-view mirror or glass coating) in front of and around the camera lens in the driver's cabin monitoring view.

The general selection of the installation area is shown in the diagram below:

[Diagram: Installation area for the main unit]



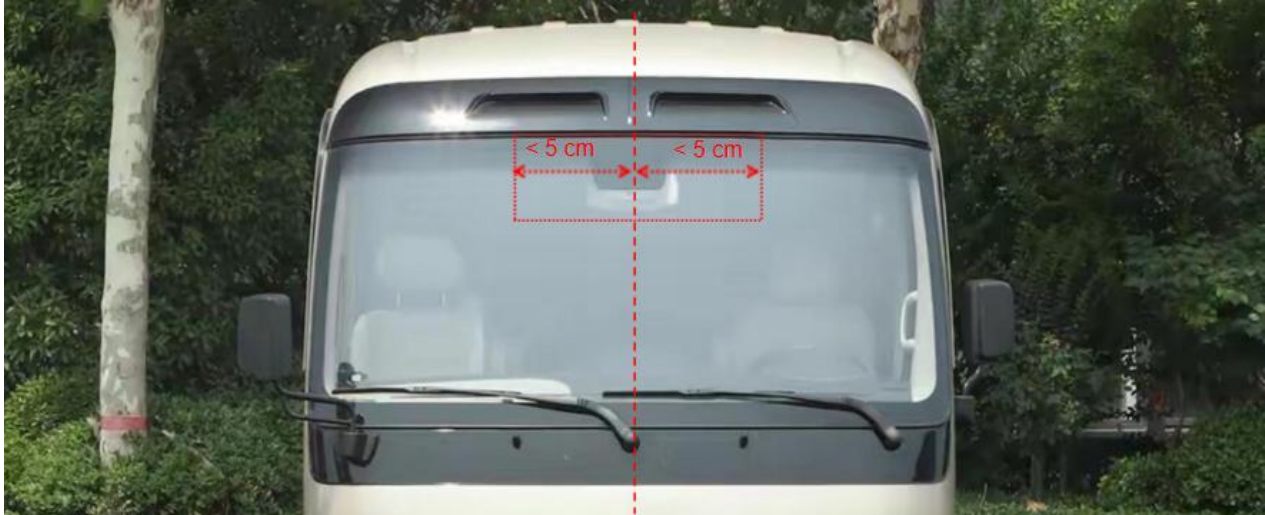

4.3 Installation of the Main Unit.

1. Park the vehicle on a level surface.
2. Clean the inside and outside of the target installation area on the windshield using an alcohol swab. Ensure that there is no dirt or debris on the glass that could obstruct the view of the road condition monitoring lens. Make sure the glass is dry.
3. Remove the protective film from the 3M tape of the mounting base and attach it to the windshield.
4. Press device firmly against the windshield for 10 seconds, ensuring that there are no air bubbles between the main unit and the glass.

4.4 Adjustment and Fixation of the Device

When fix the camera, ensure that the cabin camera screen meets the following conditions:

- a) The center of the cabin should be positioned in the middle of the screen.
- b) The cabin screen should be horizontal.
- c) The vehicle's steering wheel should be displayed in the lower left / right corner of the screen.

The properly adjusted cabin monitoring camera rendering is shown below:



**Note: Only when the device is securely connected to the vehicle, can the device be powered on. If the device is fixed after power connection, it should be powered on again before testing or use.*

4.5 Power Connection, Signal Cable, and Cable Connection

Connect the Power / ACC / GND to the vehicle's power supply line.

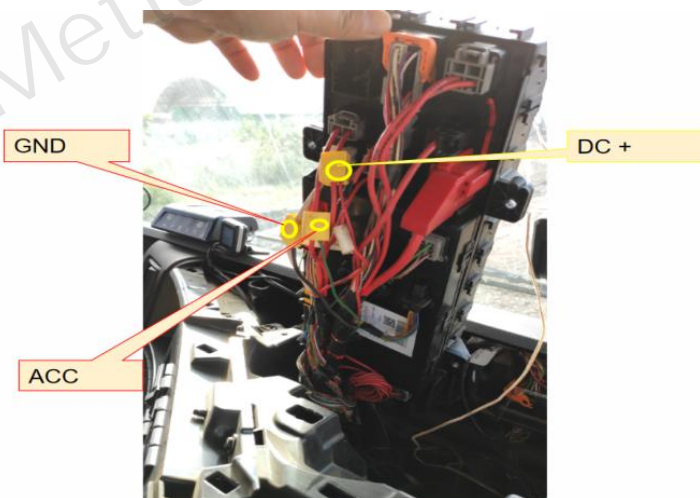
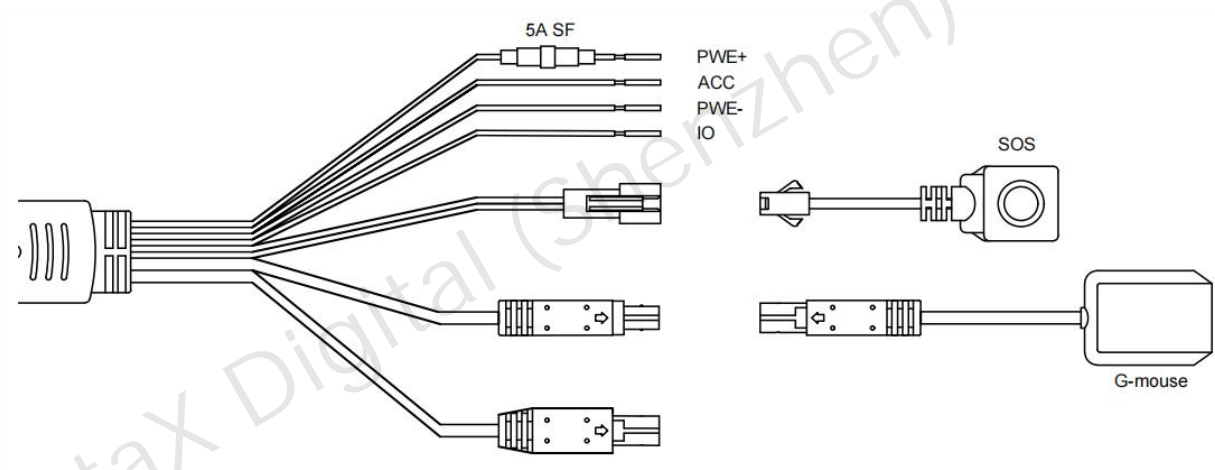

***Note:**

The power line should preferably be connected using "dedicated non-stripping connectors" (no need for stripping, to avoid the risk of electric leakage) and wrapped with insulating tape to prevent electric leakage / short circuit. If there are no special non-stripping connectors available, stripping wires can also be used for the connection. In this case, the connection process must comply with standard specifications. After the connection is completed, wrap it with insulating tape to avoid electric leakage / short circuit.

5. Device Configuration

After the device is powered on, adjust it using the configuration APP. Please refer to configuration APP user manual for instruction.

6. Acceptance and Cleaning

6.1 Cleaning

Clean up the installation site, collect and remove tools and waste materials. Return any original items to their original positions in the vehicle. The installation work is now complete.



6.2 Installation Acceptance

Conduct acceptance based on the acceptance checklist provided by the customer, focusing on the installation details and parameter settings.

- (1) Pay close attention to the parameter settings and take screenshots for documentation.
- (2) Verify the video image quality and capture and save sample videos.

After the installation is complete, take photographs of all the devices and the central console.

- (1) Capture installation position photos of all components.
- (2) Take a rendered photo of the cabin after the installation is complete.